

## Medium Power Phase Control Thyristors (Stud Version), 16 A



TO-48 (TO-208AA)

### FEATURES

- Improved glass passivation for high reliability and exceptional stability at high temperature
- High  $di/dt$  and  $dV/dt$  capabilities
- Standard package
- Low thermal resistance
- Metric threads version available
- Types up to 1200 V  $V_{DRM}/V_{RRM}$
- Designed and qualified for industrial and consumer level
- Material categorization: for definitions of compliance please see [www.vishay.com/doc?99912](http://www.vishay.com/doc?99912)



RoHS  
COMPLIANT

PRIMARY CHARACTERISTICS	
$I_{T(AV)}$	16 A
$V_{DRM}/V_{RRM}$	100 V, 200 V, 400 V, 600 V, 800 V, 1000 V, 1200 V
$V_{TM}$	1.75 V
$I_{GT}$	60 mA
$T_J$	-65 °C to +125 °C
Package	TO-48 (TO-208AA)
Circuit configuration	Single SCR

### TYPICAL APPLICATIONS

- Medium power switching
- Phase control applications

MAJOR RATINGS AND CHARACTERISTICS			
PARAMETER	TEST CONDITIONS	VALUES	UNITS
$I_{T(AV)}$		16	A
	$T_C$	85	°C
$I_{T(RMS)}$		35	A
$I_{TSM}$	50 Hz	340	A
	60 Hz	360	
$I^2t$	50 Hz	574	A <sup>2</sup> s
	60 Hz	524	
$V_{DRM}/V_{RRM}$		100 to 1200	V
$t_q$	Typical	110	μs
$T_J$		-65 to +125	°C

### ELECTRICAL SPECIFICATIONS

VOLTAGE RATINGS				
TYPE NUMBER	VOLTAGE CODE	$V_{DRM}/V_{RRM}$ , MAXIMUM REPETITIVE PEAK AND OFF-STATE VOLTAGE <sup>(1)</sup> V	$V_{RSM}$ , MAXIMUM NON-REPETITIVE PEAK VOLTAGE <sup>(2)</sup> V	$I_{DRM}/I_{RRM}$ MAXIMUM AT $T_J = T_J$ MAXIMUM mA
VS-16RIA	10	100	150	20
	20	200	300	10
	40	400	500	
	60	600	700	
	80	800	900	
	100	1000	1100	
	120	1200	1300	

#### Notes

- <sup>(1)</sup> Units may be broken over non-repetitively in the off-state direction without damage, if  $di/dt$  does not exceed 20 A/μs  
<sup>(2)</sup> For voltage pulses with  $t_p \leq 5$  ms



ABSOLUTE MAXIMUM RATINGS					
PARAMETER	SYMBOL	TEST CONDITIONS		VALUES	UNITS
Maximum average on-state current at case temperature	$I_{T(AV)}$	180° sinusoidal conduction		16	A
				85	°C
Maximum RMS on-state current	$I_{T(RMS)}$			35	A
Maximum peak, one-cycle non-repetitive surge current	$I_{TSM}$	t = 10 ms	No voltage reapplied	Sinusoidal half wave, initial $T_J = T_J$ maximum	A
		t = 8.3 ms			
		t = 10 ms	100 % $V_{RRM}$ reapplied		
		t = 8.3 ms			
Maximum $I^2t$ for fusing	$I^2t$	t = 10 ms	No voltage reapplied		A <sup>2</sup> s
		t = 8.3 ms			
		t = 10 ms	100 % $V_{RRM}$ reapplied		
		t = 8.3 ms			
Maximum $I^2\sqrt{t}$ for fusing	$I^2\sqrt{t}$	t = 0.1 to 10 ms, no voltage reapplied, $T_J = T_J$ maximum		5740	A <sup>2</sup> √s
Low level value of threshold voltage	$V_{T(TO)1}$	(16.7 % $\times \pi \times I_{T(AV)} < I < \pi \times I_{T(AV)}$ , $T_J = T_J$ maximum)		0.97	V
High level value of threshold voltage	$V_{T(TO)2}$	(I $> \pi \times I_{T(AV)}$ , $T_J = T_J$ maximum)		1.24	
Low level value of on-state slope resistance	$r_{t1}$	(16.7 % $\times \pi \times I_{T(AV)} < I < \pi \times I_{T(AV)}$ , $T_J = T_J$ maximum)		17.9	mΩ
High level value of on-state slope resistance	$r_{t2}$	(I $> \pi \times I_{T(AV)}$ , $T_J = T_J$ maximum)		13.6	
Maximum on-state voltage	$V_{TM}$	$I_{pk} = 50$ A, $T_J = 25$ °C		1.75	V
Maximum holding current	$I_H$	$T_J = 25$ °C, anode supply 6 V, resistive load		130	mA
Latching current	$I_L$			200	

SWITCHING					
PARAMETER	SYMBOL	TEST CONDITIONS		VALUES	UNITS
Maximum rate of rise of turned-on current	di/dt	$T_J = T_J$ maximum, $V_{DM} = \text{Rated } V_{DRM}$ Gate pulse = 20 V, 15 Ω, $t_p = 6$ μs, $t_r = 0.1$ μs maximum $I_{TM} = (2 \times \text{rated } di/dt)$ A		200	A/μs
				$V_{DRM} \leq 600$ V	
				$V_{DRM} \leq 800$ V	
				$V_{DRM} \leq 1000$ V	
Typical turn-on time	$t_{gt}$	$T_J = 25$ °C, at rated $V_{DRM}/V_{RRM}$ , $T_J = 125$ °C		0.9	μs
Typical reverse recovery time	$t_{rr}$	$T_J = T_J$ maximum, $I_{TM} = I_{T(AV)}$ , $t_p > 200$ μs, di/dt = - 10 A/μs		4	
Typical turn-off time	$t_q$	$T_J = T_J$ maximum, $I_{TM} = I_{T(AV)}$ , $t_p > 200$ μs, $V_R = 100$ V, di/dt = - 10 A/μs, dV/dt = 20 V/μs linear to 67 % $V_{DRM}$ , gate bias 0 V to 100 W		110	

**Note**

- $t_q = 10$  μs up to 600 V,  $t_q = 30$  μs up to 1600 V available on special request

BLOCKING					
PARAMETER	SYMBOL	TEST CONDITIONS		VALUES	UNITS
Maximum critical rate of rise of off-state voltage	dV/dt	$T_J = T_J$ maximum linear to 100 % rated $V_{DRM}$		100	V/μs
		$T_J = T_J$ maximum linear to 67 % rated $V_{DRM}$		300 <sup>(1)</sup>	

**Note**

- <sup>(1)</sup> Available with: dV/dt = 1000 V/μs, to complete code add S90 i.e. 16RIA120S90



TRIGGERING					
PARAMETER	SYMBOL	TEST CONDITIONS		VALUES	UNITS
Maximum peak gate power	$P_{GM}$	$T_J = T_J$ maximum		8.0	W
Maximum average gate power	$P_{G(AV)}$			2.0	
Maximum peak positive gate current	$I_{GM}$	$T_J = T_J$ maximum		1.5	A
Maximum peak negative gate voltage	$-V_{GM}$	$T_J = T_J$ maximum		10	V
DC gate current required to trigger	$I_{GT}$	$T_J = -65\text{ }^\circ\text{C}$	Maximum required gate trigger current/voltage are the lowest value which will trigger all units 6 V anode to cathode applied	90	mA
		$T_J = 25\text{ }^\circ\text{C}$		60	
		$T_J = 125\text{ }^\circ\text{C}$		35	
DC gate voltage required to trigger	$V_{GT}$	$T_J = -65\text{ }^\circ\text{C}$		3.0	V
		$T_J = 25\text{ }^\circ\text{C}$		2.0	
		$T_J = 125\text{ }^\circ\text{C}$		1.0	
DC gate current not to trigger	$I_{GD}$	$T_J = T_J$ maximum, $V_{DRM} =$ Rated value		2.0	mA
DC gate voltage not to trigger	$V_{GD}$	$T_J = T_J$ maximum, $V_{DRM} =$ Rated value	Maximum gate current/voltage not to trigger is the maximum value which will not trigger any unit with rated $V_{DRM}$ anode to cathode applied	0.2	V

THERMAL AND MECHANICAL SPECIFICATIONS					
PARAMETER	SYMBOL	TEST CONDITIONS	VALUES		UNITS
Maximum operating junction and storage temperature range	$T_J, T_{Stg}$		-65 to +125		$^\circ\text{C}$
Maximum thermal resistance, junction to case	$R_{thJC}$	DC operation	0.86		K/W
Maximum thermal resistance, case to heat sink	$R_{thCS}$	Mounting surface, smooth, flat and greased	0.35		
			<b>TO NUT</b>	<b>TO DEVICE</b>	
Mounting torque		Lubricated threads (Non-lubricated threads)	20 (27.5)	25	lbf · in
			0.23 (0.32)	0.29	kgf · m
			2.3 (3.1)	2.8	N · m
Approximate weight			14		g
			0.49		oz.
Case style		See dimensions - link at the end of datasheet	TO-48 (TO-208AA)		

$\Delta R_{thJC}$ CONDUCTION				
CONDUCTION ANGLE	SINUSOIDAL CONDUCTION	RECTANGULAR CONDUCTION	TEST CONDITIONS	UNITS
180°	0.21	0.15	$T_J = T_J$ maximum	K/W
120°	0.25	0.25		
90°	0.31	0.34		
60°	0.45	0.47		
30°	0.76	0.76		

**Note**

- The table above shows the increment of thermal resistance  $R_{thJC}$  when devices operate at different conduction angles than DC

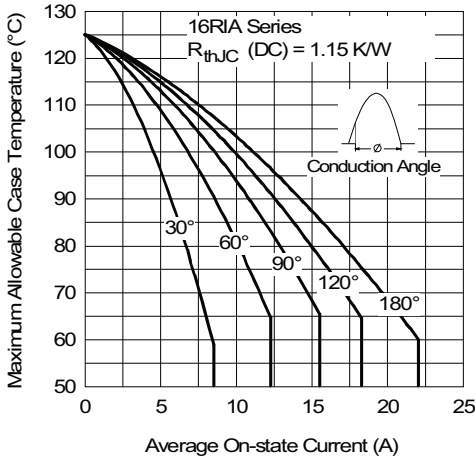

Fig. 1 - Current Ratings Characteristics

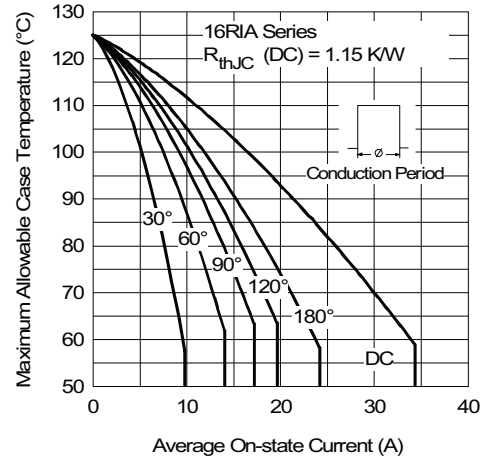

Fig. 2 - Current Ratings Characteristics

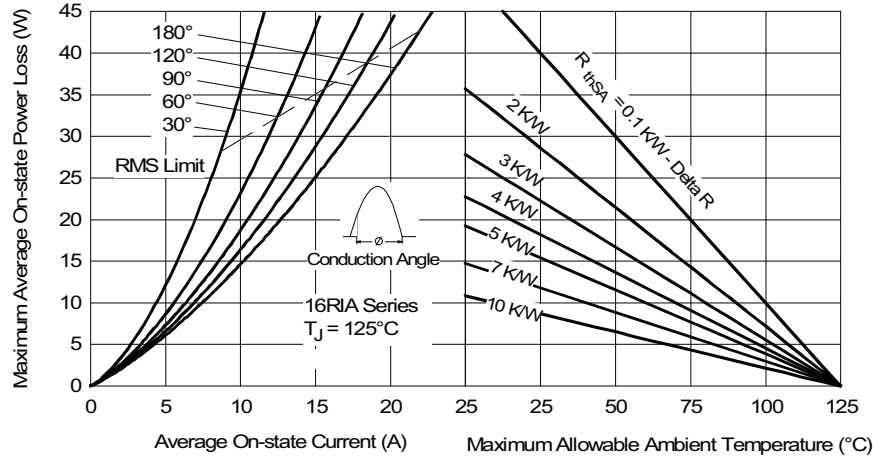

Fig. 3 - On-State Power Loss Characteristics

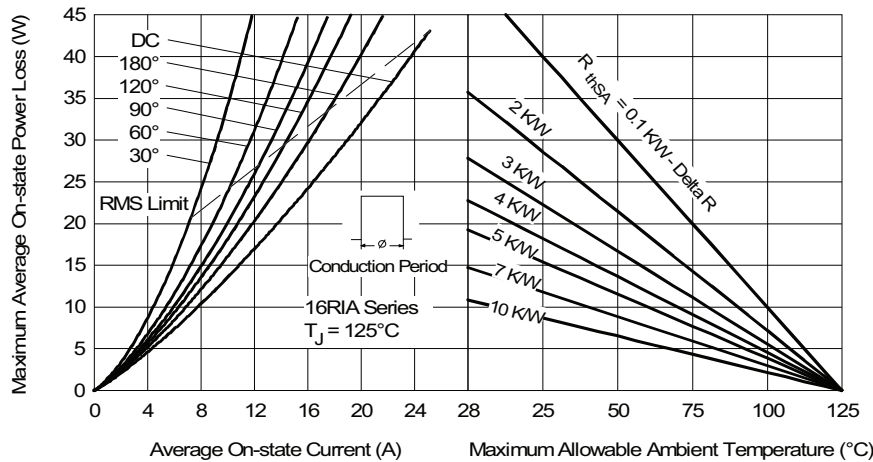

Fig. 4 - On-State Power Loss Characteristics



Fig. 5 - Maximum Non-Repetitive Surge Current



Fig. 6 - Maximum Non-Repetitive Surge Current



Fig. 7 - Forward Voltage Drop Characteristics

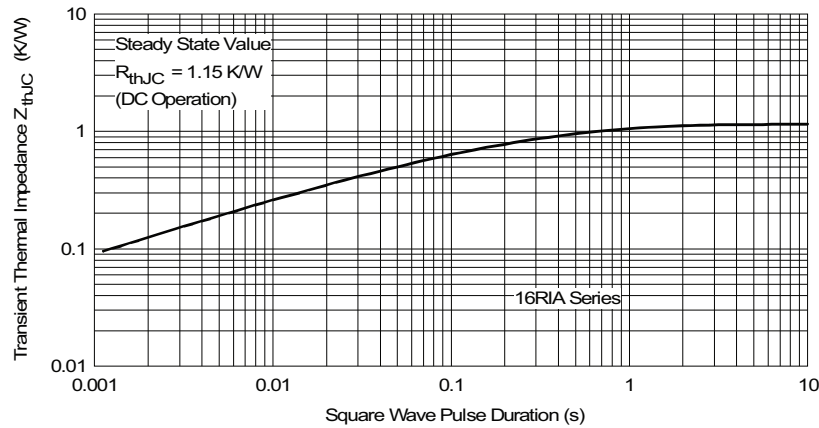

Fig. 8 - Thermal Impedance  $Z_{thJC}$  Characteristics

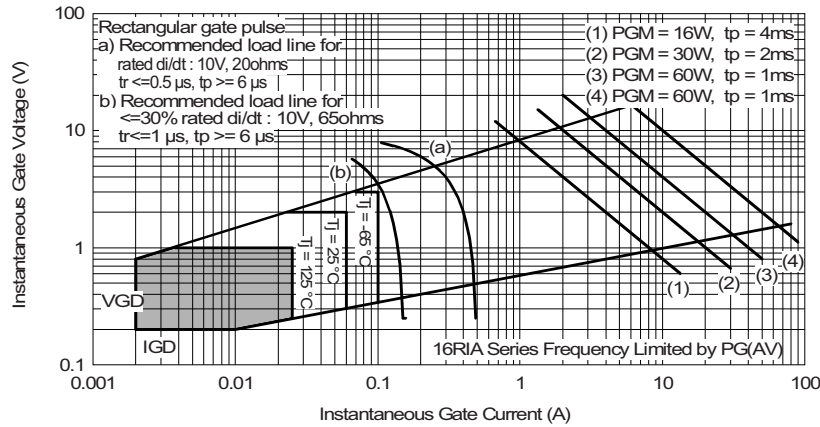

Fig. 9 - Gate Characteristics

**ORDERING INFORMATION TABLE**

Device code	<b>VS-</b>	<b>16</b>	<b>RIA</b>	<b>120</b>	<b>M</b>	<b>S90</b>
	①	②	③	④	⑤	⑥

- 1** - Vishay Semiconductors product
- 2** - Current code
- 3** - Essential part number
- 4** - Voltage code x 10 =  $V_{RRM}$  (see Voltage Ratings table)
- 5** - None = stud base TO-48 (TO-208AA) 1/4" 28UNF-2A  
M = stud base TO-48 (TO-208AA) M6 x 1
- 6** - Critical dV/dt:  
None = 300 V/μs (standard value)  
S90 = 1000 V/μs (special selection)

**LINKS TO RELATED DOCUMENTS**

Dimensions	<a href="http://www.vishay.com/doc?95333">www.vishay.com/doc?95333</a>
------------	--



## TO-208AA (TO-48)

**DIMENSIONS** in millimeters (inches)

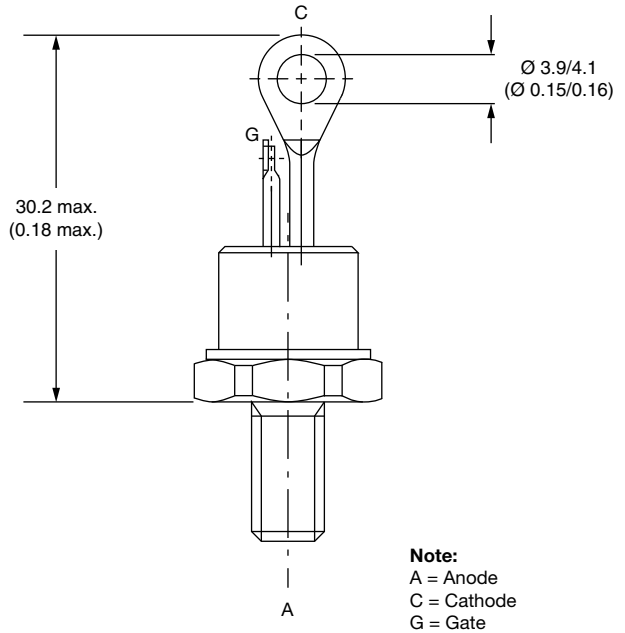



## Disclaimer

ALL PRODUCT, PRODUCT SPECIFICATIONS AND DATA ARE SUBJECT TO CHANGE WITHOUT NOTICE TO IMPROVE RELIABILITY, FUNCTION OR DESIGN OR OTHERWISE.

Vishay Intertechnology, Inc., its affiliates, agents, and employees, and all persons acting on its or their behalf (collectively, "Vishay"), disclaim any and all liability for any errors, inaccuracies or incompleteness contained in any datasheet or in any other disclosure relating to any product.

Vishay makes no warranty, representation or guarantee regarding the suitability of the products for any particular purpose or the continuing production of any product. To the maximum extent permitted by applicable law, Vishay disclaims (i) any and all liability arising out of the application or use of any product, (ii) any and all liability, including without limitation special, consequential or incidental damages, and (iii) any and all implied warranties, including warranties of fitness for particular purpose, non-infringement and merchantability.

Statements regarding the suitability of products for certain types of applications are based on Vishay's knowledge of typical requirements that are often placed on Vishay products in generic applications. Such statements are not binding statements about the suitability of products for a particular application. It is the customer's responsibility to validate that a particular product with the properties described in the product specification is suitable for use in a particular application. Parameters provided in datasheets and / or specifications may vary in different applications and performance may vary over time. All operating parameters, including typical parameters, must be validated for each customer application by the customer's technical experts. Product specifications do not expand or otherwise modify Vishay's terms and conditions of purchase, including but not limited to the warranty expressed therein.

Except as expressly indicated in writing, Vishay products are not designed for use in medical, life-saving, or life-sustaining applications or for any other application in which the failure of the Vishay product could result in personal injury or death. Customers using or selling Vishay products not expressly indicated for use in such applications do so at their own risk. Please contact authorized Vishay personnel to obtain written terms and conditions regarding products designed for such applications.

No license, express or implied, by estoppel or otherwise, to any intellectual property rights is granted by this document or by any conduct of Vishay. Product names and markings noted herein may be trademarks of their respective owners.